



MirrorVueTM

The Perfect Mirror TV

**MIRRORVUE
PRODUCT BROCHURE**



MIRRORVUE

Introducing MirrorVue, the premier smart TV mirror solution that seamlessly combines cutting-edge technology with elegant design. Tailor your MirrorVue to your exact specifications, including screen size, glass type, frame style, mounting options, and remote control functionality. Experience the perfect blend of form and function with MirrorVue's advanced customization capabilities, delivering unparalleled style and performance for your space.

FEATURES



4K UHD



Vanishing Mirror



Mirror TV



Custom Shapes and Sizes



Extra Thin TV Housing



Low Voltage (12-24V)



Extra Brightness LED Panels



Smart Touch



OLED Mirror TV



Available Frames

MIRROR GLASS OPTIONS



Silver Mirror

The TV vanishes entirely when turned off, an ideal choice for residential spaces that value a clean, modern aesthetic.



Advertisement Mirror

The TV disappears completely when turned off, a flawless solution for commercial environments seeking a clean, modern aesthetic.



Tinted Mirror

With 80% vanishing capability, the TV blends seamlessly into its surroundings, a subtle and stylish choice for living rooms, bedrooms, and home theaters.



Black Mirror

The non-vanishing black mirror glass delivers bold, dramatic visuals that make a lasting impression.



Bronze Mirror

Experience seamless style with our non-vanishing Mirror TV in a rich bronze finish, designed to bring warmth and sophistication to any space.



Gold Mirror

A non-vanishing Mirror TV that enhances your décor with a luxurious gold mirror finish, bringing a refined touch of opulence to any space.



Rose Gold Mirror

A non-vanishing Mirror TV that step into modern luxury with our stunning Rose Gold Mirror, where contemporary elegance meets timeless style.



MirrorVue
The Perfect Mirror TV



1

MirrorVue Custom Sizes

MirrorVue lets you create a smart mirror TV perfectly sized to fit your space. Enjoy all the features of MirrorVue with a custom dimension tailored to your style and needs.



2

MirrorVue Custom Shape

MirrorVue allows you to design a smart mirror TV in the exact shape you want. Whether modern, classic, or unique, customize your MirrorVue to perfectly match your space and style without compromising on advanced features and quality.



3

MirrorVue TV Sizes

Find the perfect fit for your space with our wide selection of MirrorVue TV sizes.

Available Sizes:

15.6" (720p)	55" (4K OLED)
22" (Full HD)	60" (4K)
28" (4K)	65" (4K OLED)
32" (4K)	75" (4K)
40" (4K)	85" (4K)
50" (4K)	100" (4K)

*Current Mirror Size (2500mm X 1500mm)

OLED TV

MirrorVue is the first mirror TV to feature cutting-edge OLED technology. This advanced display redefines visual excellence, delivering unparalleled color accuracy, exceptional brightness and contrast, and deep, true blacks. Experience TV viewing like never before with MirrorVue's stunning OLED clarity.



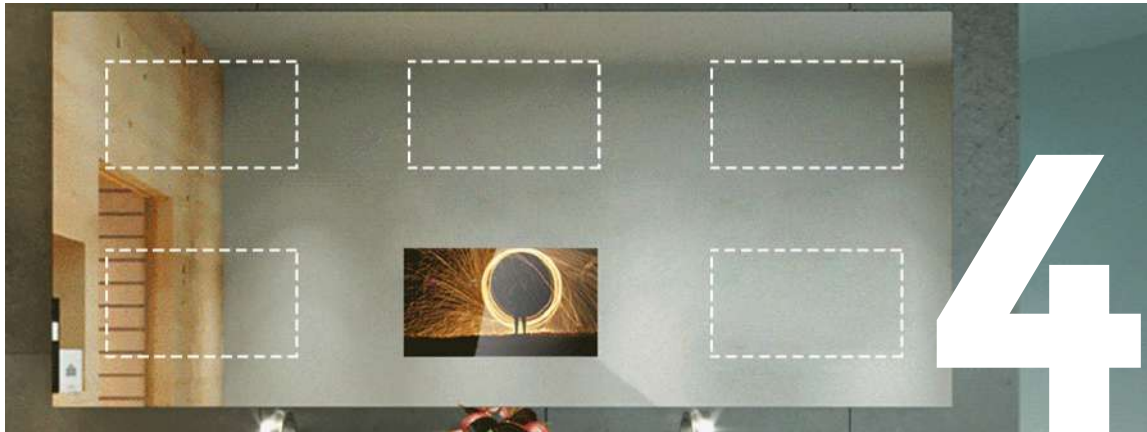

Locate TV Screen Anywhere

Tell us where you want your TV. MirrorVue's customization lets you place the screen anywhere you desire, creating a truly personalized and flexible setup, and even integrate multiple TVs within a single mirror for a seamless, versatile entertainment experience.

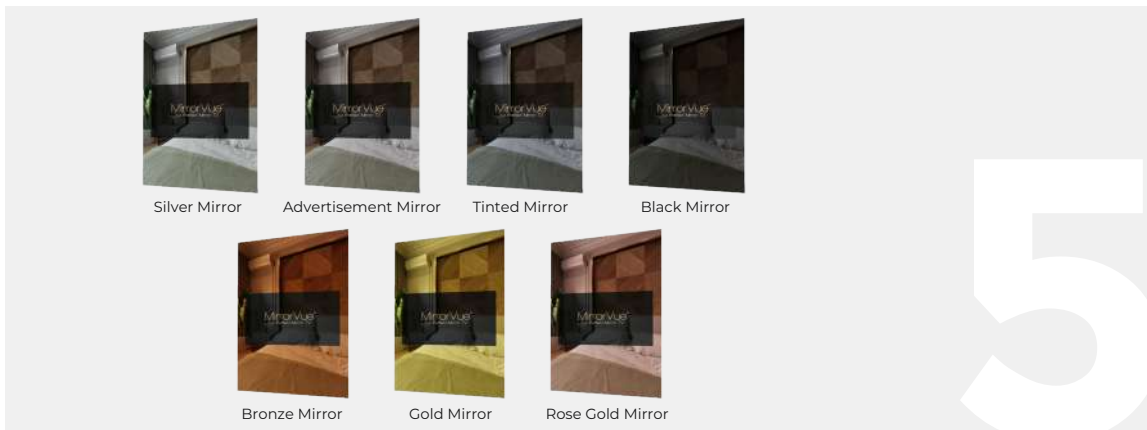

Silver Mirror

Advertisement Mirror

Tinted Mirror

Black Mirror

Bronze Mirror

Gold Mirror

Rose Gold Mirror

Choose Mirror Glass Type

MirrorVue offers exceptional versatility, perfectly suited for commercial, residential, or hospitality environments. Our premium-quality glass options include Silver, Advertisement, Tinted, Black, Bronze, Gold, and Rose-Gold Mirrors ensuring the ideal solution for any purpose or requirement.



Standard Wall Mount

Magnet Wall Mount

Recessed Wall Mount

MirrorVue Mounting Options

MirrorVue installation is quick and efficient. Whether you need space-saving built-in designs or easy-to-install options, MirrorVue offers Standard Mount, Magnet Mount, and Recessed Wall Mount solutions. Don't worry about limited mounting options, we have you covered.



Defogger

Available in a variety of shapes and sizes, MirrorVue feature a patented fog-free coating that guarantees a crystal-clear viewing experience, even in high-humidity environments such as bathrooms.

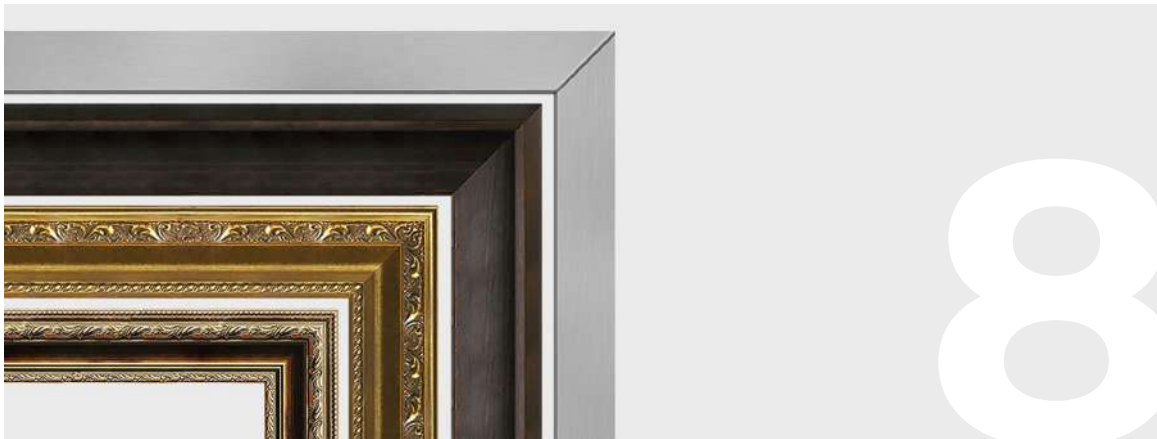

MirrorVue Frames

MirrorVue offers frames in a variety of styles, including Vauci, Renaissance, Mosaic, Mediterranean, Gatsby, Wood, Whites, Stainless Steel, Blacks, Golden, and Silver frames. These frames stand apart from traditional metal options, providing distinctive designs that enhance any space.



Operating System

MirrorVue comes with a top box compartment, designed to conveniently store Android TV, Apple TV, and other set-top devices. This innovative system allows for easy upgrades, ensuring your entertainment setup stays current for years to come.

**Note: Apple TV and other set-top devices are not included and is at the buyer's expense.*

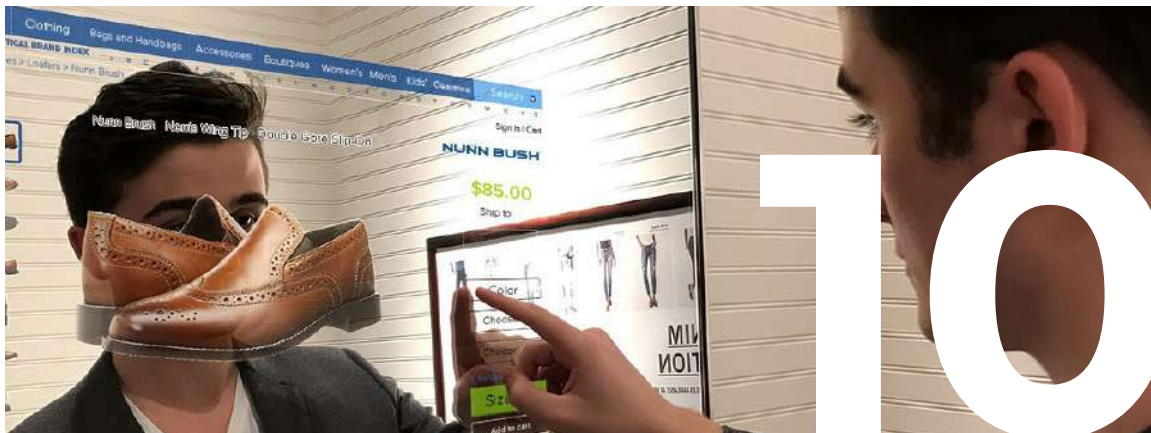

Smart Touch

Controlling your MirrorVue is now simpler than ever. Each MirrorVue comes with the option to integrate a premium touchscreen system, allowing customers to browse store websites and place orders seamlessly. Stay updated with the latest news and social media, and deliver flawless presentations at work. With endless possibilities, the experience is truly transformative.



MirrorVue Light Options

Enhance your MirrorVue experience by personalizing it with integrated lighting, Hollywood-style light, and backlight for a touch of luxury.







Cut Outs

We offer custom cutouts in mirrors to accommodate faucets and light fixtures, precisely tailored to your needs. Using advanced CNC technology, we ensure every cut is made with exceptional accuracy and precision.

WHY MIRRORVUE

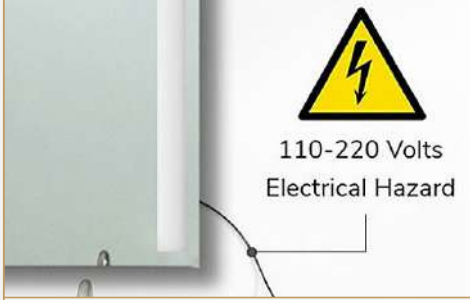
MirrorVue

Other Mirror TVs

 <p>SAFE 12 - 24 Volts Non-electrocuting</p>	<p>12-24 Volts</p>	 <p>110-220 Volts Electrical Hazard</p>
<p>12-24 volts. Easy to install and safe to us anywhere.</p>		<p>Usually 110 or 220 volts</p>
 <p>MirrorVue uses unique silver mirror TV glass which makes the TV very clear when turned on and allows the TV to completely vanish when turned off. With over 15 years of perfecting our mirror glass, we are proud to say that we offer the best on the market</p>	<p>Real Mirror TV Glass</p>	 <p>Uses low quality glass that decreases the visibility of the TV and does not completely vanish the TV when turned off.</p>
	<p>Rust Proof TV Mirror Glass</p>	
<p>Our mirror TVs are made with very high quality, corrosion and rust-free mirror glass that shows a beautiful reflection. This makes a MirrorVue a worry-free investment you will enjoy for many years to come.</p>		<p>Easy to rust over time.</p>

WHY MIRRORVUE

MirrorVue

Other Mirror TVs



Choose from a wide variety of television sizes

TV sizes 15.6" up to 100"



Other mirror TVs have limited options available



Enhance your mirror television experience with cutting-edge OLED technology, available in 55" and 65" sizes.

The Only OLED TV Mirror



Not available



MirrorVue is completely made-to-measure with extreme precision.

Made-To-Measure

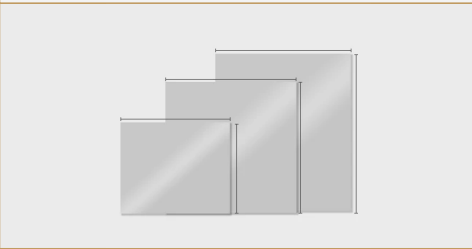







Other mirror TVs have limited options available

WHY MIRRORVUE

MirrorVue





Other Mirror TVs

	<p>Make in Any Shape</p>	
<p>MirrorVue can be made in every shape</p>		<p>Other mirror TVs have limited options available</p>
	<p>Touchscreen Available</p>	
<p>Available to all TV sizes.</p>		<p>Not available or limited to very few sizes.</p>
	<p>High Quality Speakers</p>	
<p>Speakers are located on the edges of the mirror for increased audio performance</p>		<p>Limited or not located on the edges of the mirror.</p>

WHY MIRRORVUE

MirrorVue

Other Mirror TVs

	<p>Good Wall-Mount</p>	
<p>MirrorVue has two long wall-mount rails to ensure a well-mounted mirror. Other lighted mirrors often only have a hang construction on the top, which makes the mirror move easily.</p>		<p>Not sturdy.</p>
	<p>Security Film</p>	
<p>MirrorVue comes with a security film on the back that prevents dangerous, sharp mirror parts from falling on the floor in the case the Mirror TV breaks. This makes MirrorVue compliant to be installed in public areas and for professional.</p>		<p>Easy to break with no security film.</p>

MIRRORVUE MIRROR TV SPECIFICATION

	TV Sizes												
	15.6"	22"	28"	32"	40"	50"	55"	60"	65"	75"	85"	100"	
VIDEO													
TV Display	LED Backlight						OLED	LED	OLED	LED Backlight			
Aspect Ratio	16:9												
Resolution	720p	1080p	4K, 3840 x 2160										
AUDIO													
Output	Audio Amplified, Audio Non-Amplified												
Built-in Audio Amplifier	2 x 10 Watts			2 x 15 Watts									
CASING													
IPX Rating	IPX5						IPX4						
TV Housing Material	Power Coating Aluminum												
TV Housing Thickness	33mm									50mm			
TV SYSTEM													
Voltage Input	12 Volts VDC			24 Volts VDC									
Inputs	3 x HDMI			2 x HDMI (CEC, ARC and EDID), Power									
SIZES													
TV Sizes (inch)	13.55 x 7.62	18.78 x 10.56	24.45 x 13.44	27.50 x 15.47	34.57 x 19.11	43.14 x 24.27	47.64 x 26.79	50.00 x 28.40	56.24 x 31.63	64.97 x 36.55	74.61 x 41.97	84.96 x 47.91	
TV Sizes (mm)	344 x 194	477 x 268	621 x 341	698 x 393	878 x 485	1096 x 616	1210 x 680	1270 x 721	1428 x 804	1650 x 928	1895 x 1066	2158 x 1217	
Min. Mirror Size (inch)	19.4 x 21.4	20.7 x 24.7	26.6 x 28.8	29.2 x 30.4	36.3 x 34.1	44.6 x 39.4	49.3 x 41.7	51.7 x 43.5	58.5 x 46.6	67.2 x 51.7	77.4 x 52.6	87.7 x 58.3	
Min. Mirror Size (mm)	493 x 543	526 x 628	675 x 732	742 x 773	922 x 866	1133 x 1000	1251 x 1060	1314 x 1106	1485 x 1183	1707 x 1312	1965 x 1337	2228 x 1480	







MirrorVue Standard Size for Single Sink



DETAILS

- Comes in Silver glass.
- Ready to Use: Fully assembled and easy to wall-mount.
- Slim Profile: Just 38mm thick.
- Completely Vanishing TV: Functions as a mirror when turned off.
- Smart Technology: Stream, browse, and enjoy built-in features.

STANDARD EQUIPPED ACCESSORIES

						
Smart TV	Android TV Box	Smart Mirror	Wi-Fi / LAN	Invisible Touch Buttons	Built-in Speakers	Zepp Remote Pro

STANDARD MIRROR SIZES

Product Code	Width		Height	
	Inches	Millimeters	Inches	Millimeters
MIV-25X30	25"	635mm	30"	762mm
MIV-30X36	30"	762mm	36"	914mm
MIV-36X36	36"	914mm	36"	914mm
MIV-40X36	40"	1016mm	36"	914mm

AVAILABLE TV SIZES

15.6" (Diagonal size, 720p)
22" (Diagonal size, Full HD)
28" (Diagonal size, Ultra HD)
32" (Diagonal size, Ultra HD)

MirrorVue Standard Size for Double Sink

DETAILS

- Comes in Silver glass.
- Ready to Use: Fully assembled and easy to wall-mount.
- Slim Profile: Just 38mm thick.
- Completely Vanishing TV: Functions as a mirror when turned off.
- Smart Technology: Stream, browse, and enjoy built-in features.

STANDARD EQUIPPED ACCESSORIES



Smart TV



Android TV Box



Smart Mirror



Wi-Fi / LAN



Invisible Touch Buttons



Built-in Speakers



Zepp Remote Pro



STANDARD MIRROR SIZES

Product Code	Width		Height	
	Inches	Milimeters	Inches	Milimeters
MIV-48X36	48"	1219mm	36"	914mm
MIV-60X36	60"	1524mm	36"	914mm
MIV-72X36	72"	1829mm	36"	914mm
MIV-72X42	72"	1829mm	42"	1067mm

AVAILABLE TV SIZES

15.6" (Diagonal size, 720p)
22" (Diagonal size, Full HD)
28" (Diagonal size, Ultra HD)
32" (Diagonal size, Ultra HD)



ANDROID TV BOX

DETAILS

- MirrorVue optionally includes a built-in Android TV box, offering crystal-clear picture quality and access to popular streaming apps, all seamlessly hidden behind the mirror.

Note: This feature is available only with standard MirrorVue orders. For custom-made, it is considered an add-on. Android TV Box operates independently from the MirrorVue Mirror TV. Any technical issues, malfunctions, or performance concerns related to the Android TV Box are not covered under Evervue's scope of support, warranty, or responsibility. Evervue shall not be held liable for any issues arising from third-party devices, and all related concerns must be directed to the respective manufacturer or service provider of the device.



EXTENSION POWER CORD

DETAILS

- Offers an option for a replaceable or additional 1.5 m or 6 m cord only for 12" to 32" TV
- Offers an option for a replaceable or additional 3 m extension cord only for 40" to 100" TVs.



REPLACEMENT POWER SUPPLY

DETAILS

- Using power supplies other than the one provided with your MirrorVue, even if they match the same specifications, it may damage the product and void the warranty.
- Before ordering a replacement, please contact support at support@evervue.com so we can ensure the correct power supply is provided.

Note: The power supply may vary depending on whether the MirrorVue is standard, custom-made, or based on the TV size.



EVERVUE REMOTE

DETAILS

- This remote is replaceable and compatible exclusively with EverVue TVs.

**Note: Not waterproof*

SW50 RECESSED SPEAKERS

DETAILS

- Recessed and moisture-resistant
- Standard set of 2
- Exceptional audio quality
- Ideal for both indoor and outdoor use
- Compatible with other TV and audio systems

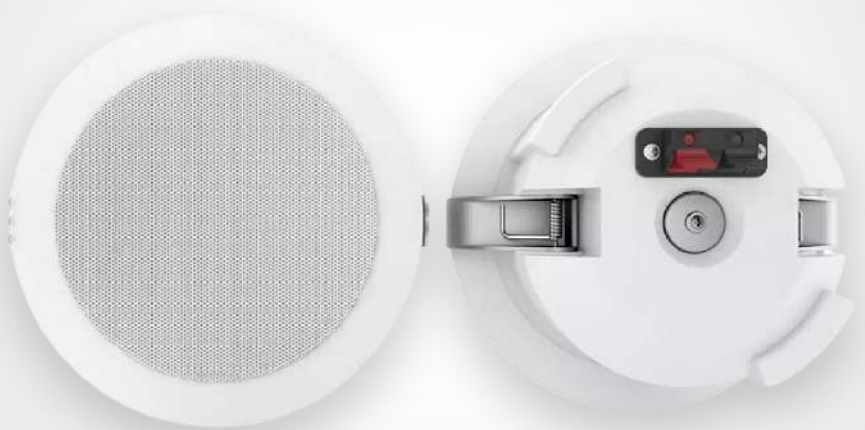

Specifications

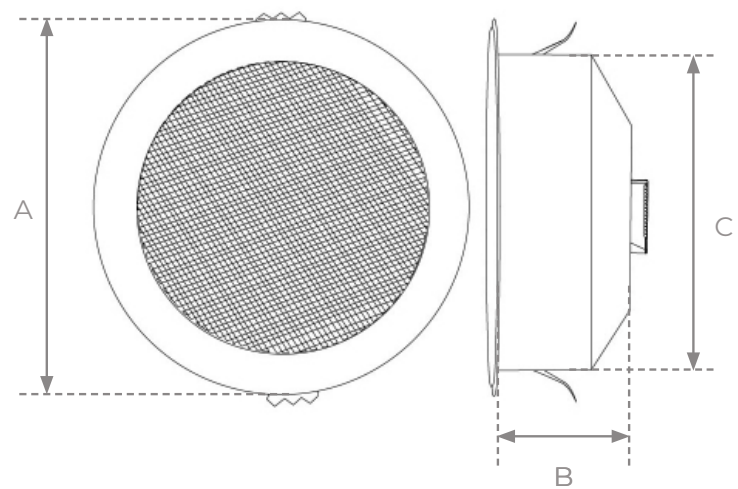

A	6.00" / 152mm
B	2.80" / 71mm
C	5.20" / 132mm

SW80 RECESSED SPEAKERS

DETAILS

- Recessed and moisture-resistant
- Standard set of 2
- Exceptional audio quality
- Ideal for both indoor and outdoor use
- Compatible with other TV and audio systems

Specifications

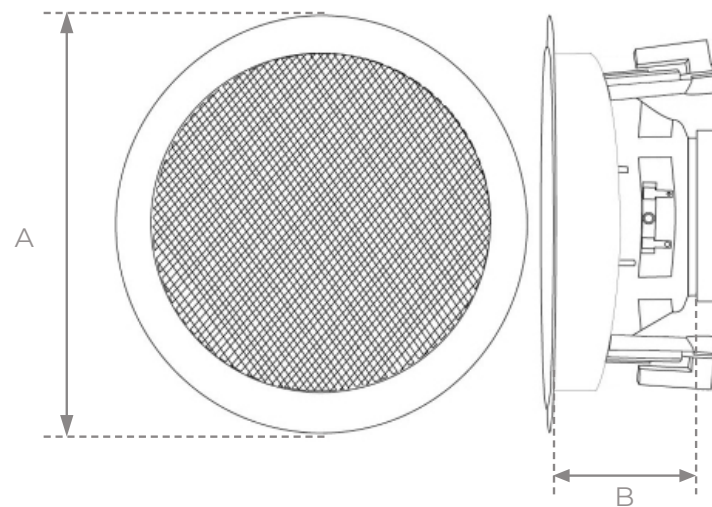

A	8.00" / 203mm
B	3.50" / 89mm





AQUA WATERPROOF REMOTE

DETAILS

- Just when it comes to precision, convenience, and water-resistant capability, the Aqua remote stands out. With the latest technology, the Aqua remote is first in its class, offering exceptional performance in wet environments. Perfect for spas, pools, hot tubs, and showers, it's IPX6 rated for superior water resistance. Stay connected to all your favorite programs in style, even in the toughest conditions.



ZEPP REMOTE PRO

DETAILS

- Includes a holder equipped with suction cups.
- Compatible Devices: PC, Smart TV, Set-top Box, Tablet, Game Player, etc.
- Supported Operating Systems: Windows, Mac OS, Android, and Linu

Features:

- Wireless QWERTY Keyboard
- 360° non-directional remote control
- Wireless 2.4G USB receiver, Plug and Play



RM100 WIRELESS DIMMER

DETAILS

- This remote control is designed exclusively for our specially crafted mirrors, offering wireless functionality to effortlessly adjust the brightness.
- For 1 MirrorVue product only.
- Battery operated remote.



RM150 WIRELESS DIMMER

DETAILS

- This remote control is exclusively designed for MirrorVue products, offering wireless functionality for effortless brightness adjustment and power control. It can manage up to 6 MirrorVue products through a wireless RF system, with a range of up to 6 meters.
- Battery operated.



RM200 WIRELESS DIMMER

DETAILS

- Recessed wall plate - spin dial.
- This remote control is exclusively designed for MirrorVue products. It features wireless functionality (RF system) for better operation. You can wirelessly adjust the brightness levels of the light and control the on/off function. The control range can reach up to 6 meters.
- Battery operated remote.



RM250 WIRELESS DIMMER

DETAILS

- Table-top model - spin dial.
- This remote control is exclusively designed for MirrorVue products. It features wireless functionality (RF system) for better operation. You can wirelessly adjust the brightness levels of the light and control the on/off function.
- Battery operated remote.



RM130 WIRELESS DIMMER

DETAILS

- Conveniently, you can dim the light wirelessly with a multi-color wireless dimmer.
- Our premium wireless (RF) dimmers let you adjust light output from up to 6 meters away.
- Easily add a dimmer switch to customize both brightness and color settings.
- Battery operated.



TRUE LIGHT WIRELESS DIMMER

DETAILS

- Features wireless functionality (RF system) for better operation. You can wirelessly adjust the brightness levels of the light and control the on/off function.
- Choose from the full spectrum between 2700k and 6200k.
- Battery operated remote.

MirrorVue™

The Perfect Mirror TV

Phone: +971 58 571 5230

Whatsapp: +971 58 571 5230

Email: info@evervue.ae

www.mirrorvue.ae

Evervue Middle East (FZE)

Sharjah Airport International Free Zone

Gold Park Q1-2-063

Sharjah, United Arab Emirates

Explore more of our products:

Instagram: [evervueofficial](https://www.instagram.com/evervueofficial)

Facebook: [evervueofficial](https://www.facebook.com/evervueofficial)

www.evervue.ae

Information is subject to change without prior notification.